

# Lower River System Quagga Mussel Control Study



**United Water**  
CONSERVATION DISTRICT

Board of Directors ▾ Resource Conservation ▾ News & Outreach

- Habitat Conservation > Plan
- Groundwater Management >
- Santa Felicia Dam
- Freeman Diversion > **Freeman Diversion Invasive Species Control Study** 
- Pumping Trough Pipeline >



**AECOM**

## Freeman Diversion Facilities Invasive Species Control Options Assessment and Engineering Feasibility Study

**FINAL**  
September 27, 2016

Prepared For:  
United Water Conservation District  
Santa Paula, CA

Prepared By:  
AECOM  
Camarillo, CA

# Quagga Mussel Control Options

CHEMICAL	BIOLOGICAL	PHYSICAL
Potassium Permanganate	Proprietary Molluskicides	Ultraviolet Light
Chlorine		Thermal
Chloramines		Filtration
Chlorine Dioxide		Coatings/Resistant Materials
Ozone		Turbulence
Deoxygenation		Alternative Sources
pH Control		O&M
Copper/Potassium Sulfate		
Proprietary Molluskicides		

# Quagga Mussel Size

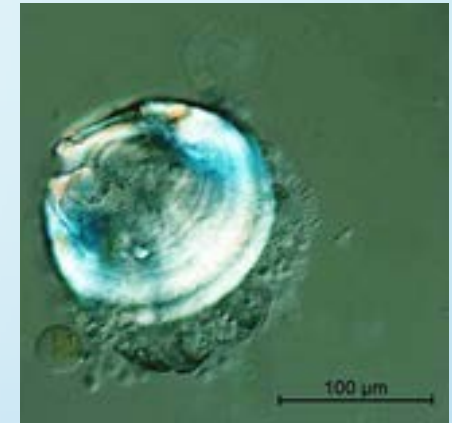
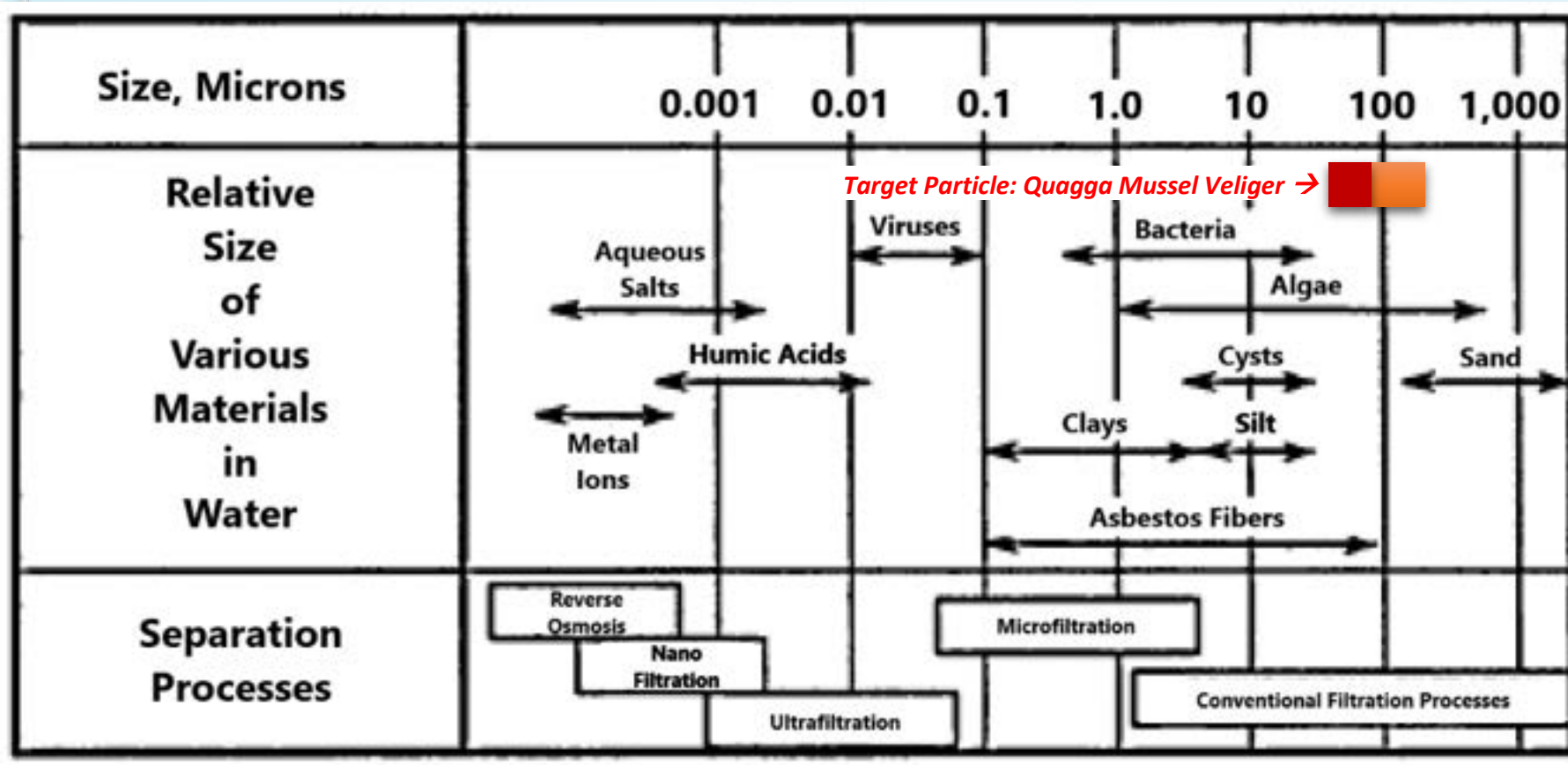

*Quagga Mussel Veliger  
Typical Size Ranges from  
80 to 200 μm*

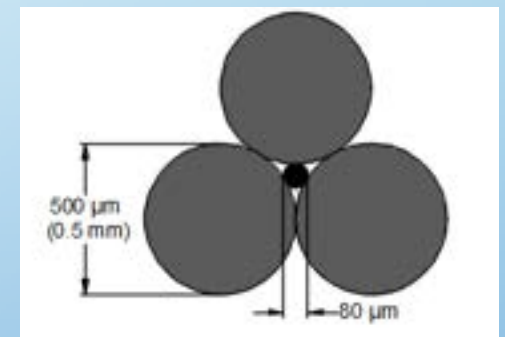

*Generalized Filtration  
by Straining of 80 μm  
Particle*

 Quagga Mussel Veliger – Ability to Pass Through Opening Smaller than Actual Size

 Quagga Mussel Veliger – Actual Size

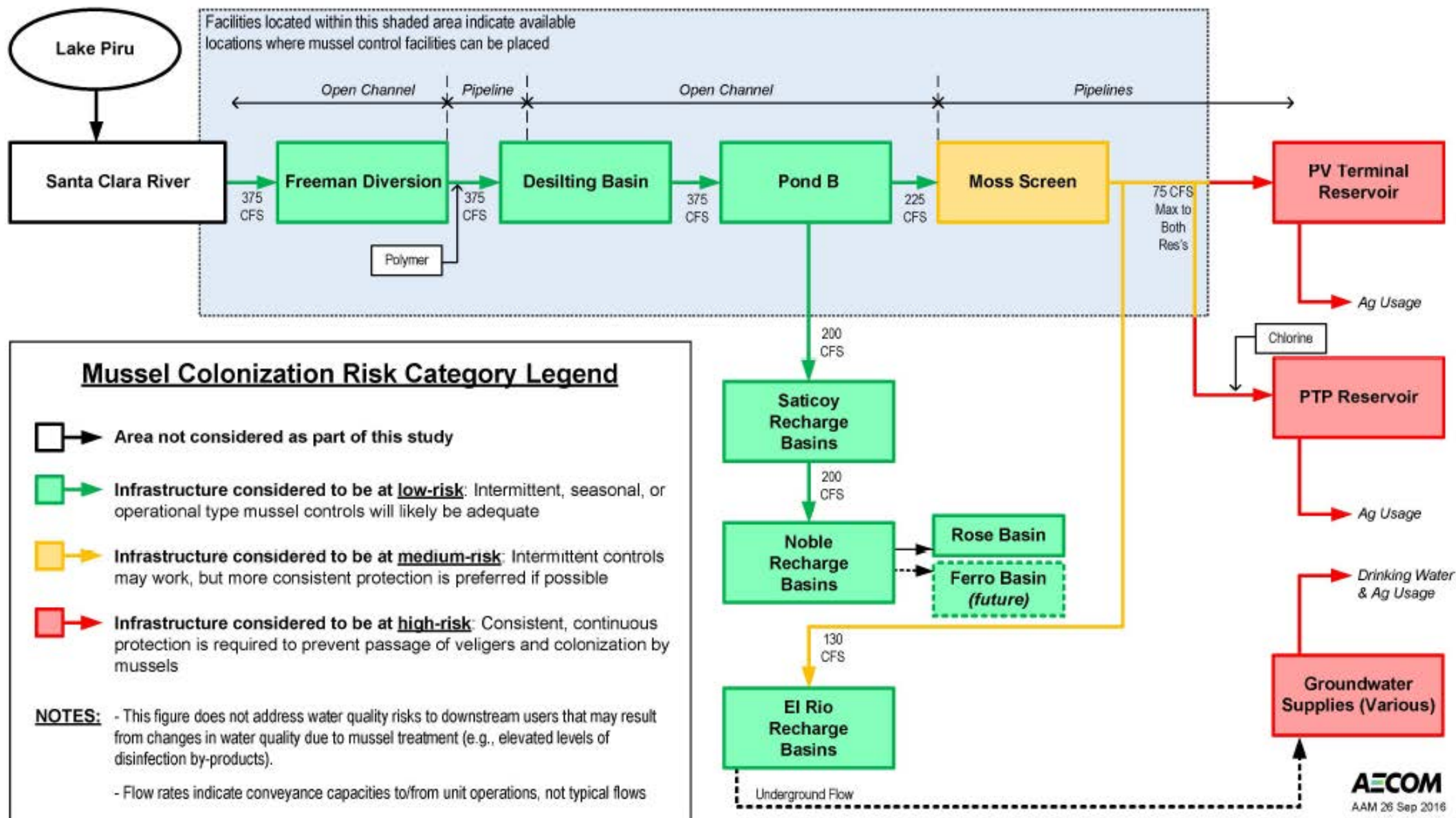



Figure 6-1. Infrastructure Overview and Locations Requiring Veliger/Mussel Control

**Table 7-2. Multi-Criteria Analysis Categories and Resulting Rankings for Mussel Control Alternatives**

Alternative	MCA Category Scoring From 1 to 5 (5 is Best)							
	Life-cycle Cost	Permitting	Constructability	Need for Secondary O&M	Footprint	Complexity	Additional Testing Required	Overall Risk Protection
1. River Infiltration Gallery	1	1	1	1	1	1	1	5
2a. Chemical Feed at Freeman	1	2	2	5	1	1	1	2
2b. Chemical Feed After Desilting Basin	1	2	2	5	1	1	1	2
3. Pond Infiltration Gallery	2	5	4	2	2	2	1	5
4. Increased Pumping at Recharge Basin	3	4	4	2	5	1	5	5
5a. Chemical Feed Before Moss Screen	4	4	4	3	2	2	2	2
5b. Chemical Feed After Moss Screen	4	4	4	2	2	2	2	2
6. Pre-Reservoir Chemical Feed	4	3	3	1	3	2	2	3
7. Non-Capital Facility Control	5	5	5	1	5	3	5	2
<b>MCA Category Weightings:</b>	<b>30%</b>	<b>5%</b>	<b>5%</b>	<b>10%</b>	<b>5%</b>	<b>10%</b>	<b>10%</b>	<b>25%</b>

RANK	ALTERNATIVE	RELATIVE PERFORMANCE	OVERALL RISK PROTECTION	20-YEAR LIFE CYCLE COST (MILLIONS OF \$)	
				MIN	MAX
1	Non-Capital Facility Control	1.00	2	\$3.4	\$7.0
2	Increased Pumping at Recharge Basin	0.99	5 	\$22.8	\$41.0
3 (TIE)	Pond Infiltration Gallery	0.80	5	\$32.4	\$53.5
3 (TIE)	Chemical Feed Before Moss Screen	0.80	2	\$10.6	\$24.6
3 (TIE)	Pre-Reservoir Chemical Feed	0.80	3	\$4.7	\$10.5
4	Chemical Feed After Moss Screen	0.77	2	\$8.4	\$19.0
5	River Infiltration Gallery	0.55	5	\$41.8	\$100
6 (TIE)	Chemical Feed at Freeman	0.48	2	\$45.3	\$85.6
6 (TIE)	Chemical Feed After Desilting Basin	0.48	2	\$22.8	\$53.5

 Most likely to guarantee 100% removal of quagga veligers

**Additional Slides  
(Not Used)**

# OPERATIONAL SCENARIOS

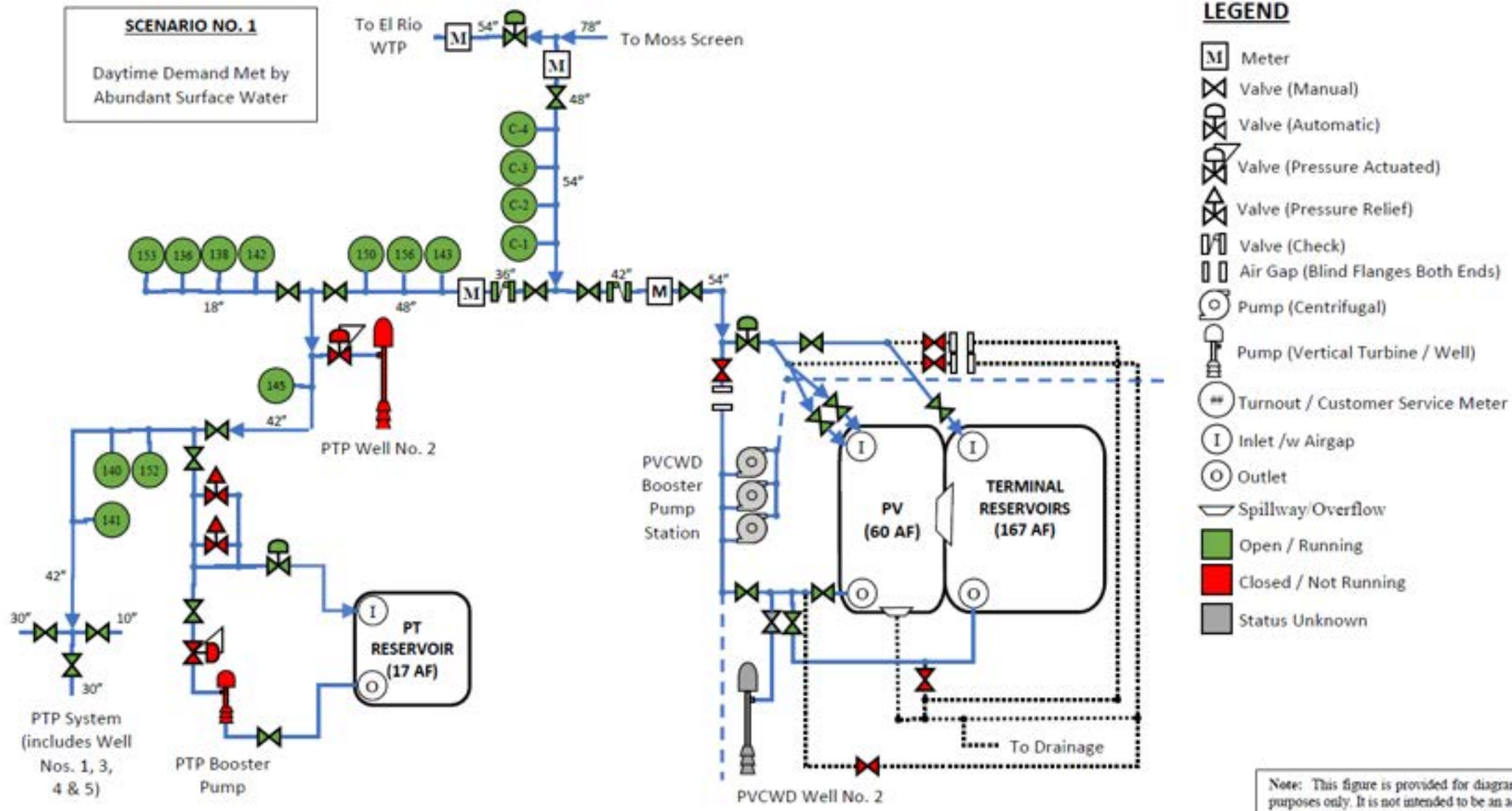

Note: This figure is provided for diagrammatic purposes only. It is not intended to be an accurate representation of the geographic locations and scale of the features shown.